

Ø 397

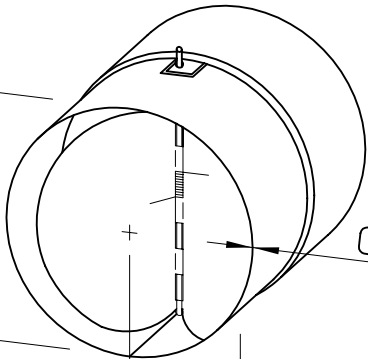

0,75

160